

POLARIS FLASH METER

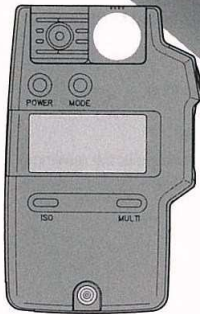

**FLASH METER
FLASHMÈTRE
BLITZBELICHTUNGSMESSER
FLASHMETRO**

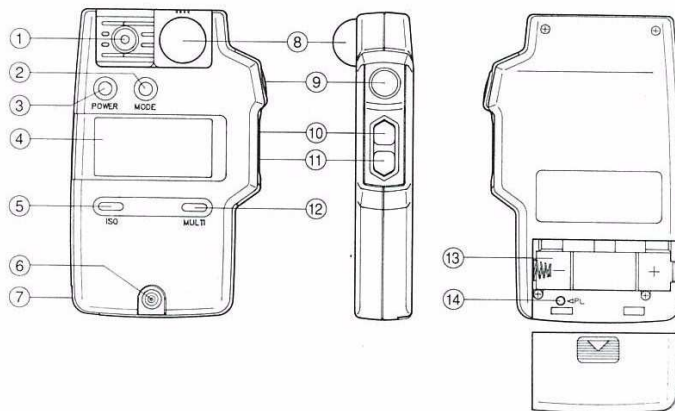

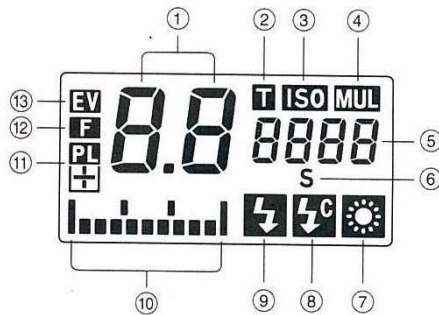

Identification:

1. Sensor
2. Mode Selector Button
3. Power Button
4. LCD Display
5. ISO Selector
6. Sync Terminal
7. Strap Lug
8. Incident Sphere
9. Measure/Trigger Button
10. Up Key
11. Down Key
12. Multiple Flash Button
13. Battery Compartment
14. Program Level (P.L) Button

LCD Display Identification:

1. f/stop, EV Value, Over Range (Eo), Under Range (Eu) and Battery Check (b.c.)
2. Shutter Speed (Time) Mode Icon
3. ISO Mode Icon
4. Multiple Flash Mode Icon
5. Shutter Speeds, ISO Setting and Multiple Flash Indicator
6. Full Second Indicator
7. Ambient Measuring Mode Icon
8. Corded Flash Mode Icon
9. Cordless Flash Mode Icon
10. Analog Scale (battery check/fractional readings)
11. Program Level (P.L.) Indicator
12. f/stop Mode Icon
13. EV Mode Icon

Battery Installation

The meter is powered by one 1.5 volt (size AA) alkaline battery.

1. Remove the Battery Compartment cover by lightly pressing the grooved area and sliding the cover in the direction indicated by the arrow.
2. Insert a new battery into the Battery Compartment (13) following the polarity symbols.
3. Replace the Battery Compartment Cover.

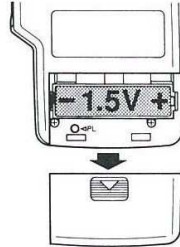

Battery Check / (Low Battery Warning)



The Battery Check function is automatically engaged whenever the meter is turned on. For approximately three seconds after pressing the Power Button (3), the analog scale will indicate the voltage level of the battery. If the voltage level of the battery drops below minimum requirements, no level will be shown. This indicates that a new battery is required.

Automatic Power Off

To maximize battery life, the meter will automatically shut down after five minutes if not in use. The meter is equipped with a memory feature that retains all settings (ISO film speed, Program Level, etc.) when the meter is turned off or the battery is changed.

Selecting a Measuring Method

Depending on the lighting situation and the subject being photographed, you must select either an Incident or Reflected Measuring Method. Following is a brief description of each method.

Incident Light Readings:

Incident light readings are made by measuring the light that is falling on the subject. Reproduction of light and dark tones will be accurate in the final image because the reflectance (or lack of reflectance) of the subject does not affect the reading. Because the hemispherical incident dome simulates a three dimensional subject, incident light readings are ideal for most situations.

How to take Incident Light Readings

1. Slide the Incident Sphere (8) to the left until it clicks into position.
2. Position the meter near the principle point of the subject with the sphere facing the camera lens. In situations where there is fairly even illumination (i.e. outdoors under clear sky), it is not crucial to position the meter near the subject. The meter may be held in line with the subject with the Incident Sphere (8) facing the camera lens.

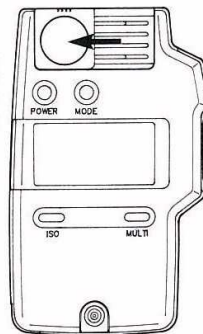
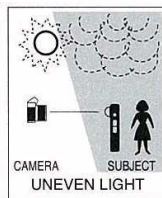
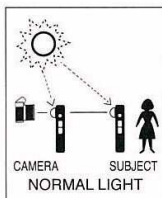

Reflected Light Readings:

Reflected light readings are made by measuring the light that is reflected by each subject in the camera field of view. When illumination is not even within a scene, representative readings must be made of all light and dark areas and then averaged in order to determine the proper exposure.

How to take Reflected Light Readings

1. Slide the Incident Sphere (8) to the right until it clicks into position.
2. From the camera position, aim the light sensor towards the subject area to be metered. Keep in mind that the light sensor will see all light and dark areas within a 40° field of view (similar to that of the camera). Make sure not to cast any unwanted shadows on the subject when taking reflected light measurements.

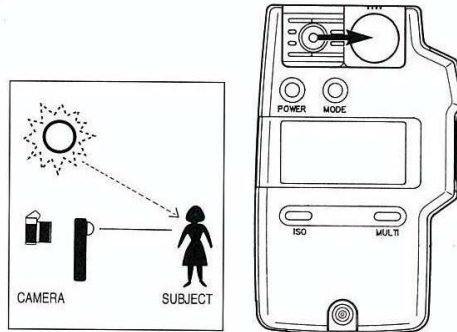



TAKING EXPOSURE READINGS

Turning The Meter On / Setting the ISO Film Speed

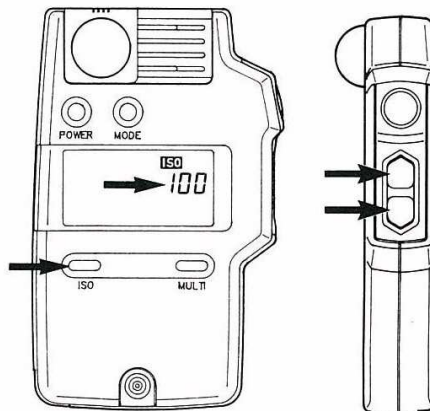
1. Press the Power button (3).
Note the automatic Battery Check as previously described.
2. Press and hold the ISO Selector Button (5).
3. Using the Up Key (10) or Down Key (11), select the desired ISO film speed.





Ambient Mode (f/stop readings)

1. Turn the meter on and set the ISO film speed as previously described.
2. Press the Mode Selector Button (2) until the Ambient Mode , f/stop Mode , and Shutter Speed  icons appear.
3. Position the meter and push the Measuring/Trigger Button to obtain a reading. The proper f/stop for the corresponding shutter speed will be displayed. The Analog scale (directly below the f/stop) indicates fractional readings in 1/10 stop increments. For shutter speeds of one second or longer, the letter "S" will appear directly below the shutter speed value.
4. Use the Up Key or Down Key to obtain the desired f/stop and shutter speed combination.

If the reading is under or over the measuring range, the error message (over E_o or under E_u) will flash, or "O" will appear as the f/stop.





Ambient Mode (EV Value)

1. Press the Mode Selector Button (2) until the Ambient Mode  and EV Mode  icons appear.
2. Position the meter and push the Measuring/Trigger Button (9) to obtain a reading. The proper value will be displayed. The Analog scale (directly below the f/stop) indicates fractional readings in 1/10 increments.



Flash Modes

Cordless Flash Modes:

1. Press the Mode Selector Button (2) until the Cordless Flash Mode  icon appears.
2. Using the Up Key (10) or Down Key (11), select the sync speed of your camera.
3. Position the meter and press the Measuring/Trigger Button (9). This will clear the previous reading and prepare the meter to measure the next flash (triggered manually or via remote control). The Cordless Flash Mode  icon will blink while awaiting the flash.
4. Fire the flash and obtain the f/stop (shutter speed cannot be changed in this mode).

The meter may not sense the flash if it is weaker than the ambient light. If this happens, switch to corded flash mode.

Corded Flash Mode:

1. Press the Mode Selector Button (2) until the Corded Flash Mode  icon appears.
2. Using the Up Key or Down Key, select the Sync Speed of your camera.
3. Attach the flash sync cord or remote control trigger to the Sync Terminal (6).
4. Position the meter and push the Measuring /Trigger Button (9) to fire the flash and obtain the proper f/stop.



Multiple Flash Mode

The Multiple Flash Mode is used to determine how many times the flash must be fired to obtain a desired f/stop. This feature can be used in the Cordless and Corded Flash Modes.

1. Using the corded or cordless method, fire the flash once and obtain a reading.
2. Press and hold the Multiple Flash Button (12). The Multiple Flash **MUL** Icon will appear on the LCD display.
3. While holding the Multi Button (12), press the Up Key (10) or Down Key (11) until the desired f/stop is reached. The number below the **MUL** Icon indicates the number of times the flash must be fired to achieve that f/stop.

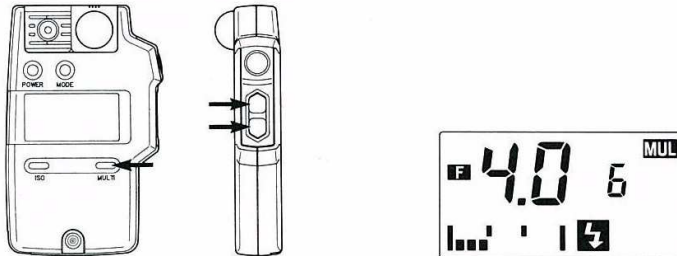

Program Level (P.L.) Feature

The Program Level feature allows you to pre-set your the meter to your preferred exposure readings. By adjusting the Program Level, the meter will automatically adjust readings to overexpose or underexpose by as little as a tenth of an f/stop or as much as 9/10 of an f/stop.

1. With the meter turned on, remove the Battery Compartment cover.
2. Press the Program Level (P.L.) Button (14) located just below the battery. The Program Level Icon and Analog Scale will appear on the LCD display.
3. While holding the Program Level button, use the Up Key (10) or Down Key (11) to adjust the level of the meter. A "plus" or "minus" symbol will appear in the Program Level, indicating over or underexposure, respectively. Each symbol on the Analog Scale represents 1/10 stop.

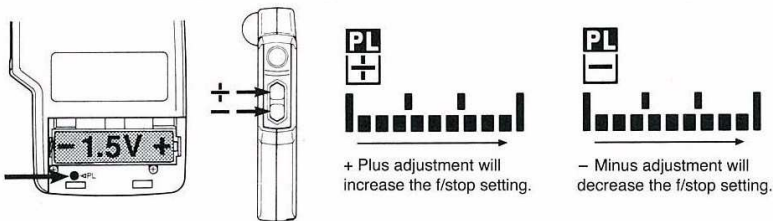

4. The Program Level **P** Icon will continue to flash as long as the meter is the pre-set program mode. Turning the meter off or changing the battery will not erase the pre-set program.
5. To return to normal reading levels, repeat step 3 using the Up or Down Key to return the Program Level to zero (no "plus" or "minus" sign appears in the Program Level icon).

This feature is also useful when it is necessary to make corrections for the measurement under different type of light source.

Taking Care of Your meter

- Do not put excessive pressure on the LCD display.
- Do not drop the meter or subject it to excessive shock, vibration or temperature extremes.
- Remove battery and store in dry cool place when not in use.
- Keep the meter clean and dust-free.
- Dust the exterior surfaces regularly with a soft silicon treated cloth, clean cotton cloth, or use pressurised air. Never use chemical or organic solvents.

Specifications:

Type:	Hand-held meter for measuring ambient and flash light exposure.
Measurement:	Incident and reflected light measurements. Ambient and flash light measurement.
Sensor:	Silicon Photo Diode.
Acceptance Angle:	35 degrees in reflected light measurement.
Measuring Modes:	Ambient, Ambient/EV, Flash Cordless and Flash Corded.
Measuring Range:	Ambient: EV 1 to 19.9 (ISO/100) in 1/10 increments. Flash: f/2 to f/90.9 (ISO/100) in 1/10 increments.
f/No. Range:	f/0.5 to f/90 in 1/10 stop increments.
Shutter Speed Range:	Ambient: 60 to 1/8000 sec. with 1/25, 1/50, 1/75, 1/200 and 1/400 sec. extra speeds. Flash: 1 to 1/500 sec. with 1/25, 1/50, 1/75, 1/80, 1/90, 1/100, 1/200 and 1/400 sec. extra speeds.
Film Speed Range:	ISO 3 to 8000 in 1/3 increments.
Multi-flash Range:	2 to 9 flashes.
Readiness for Flash:	5 minutes.
Memory:	Measuring Modes, ISO Speed and Shutter Speed are stored in memory.
Program Level:	Max between + 0.9 to - 0.9 stops can be set easily using buttons.
Power Source:	One size AA 1.5V battery.
Dimensions:	119 × 63 × 21mm; 4 ^{11/16} × 2 ^{1/2} × 7/8"
Weight (w/out Batt):	93g; 3 ^{1/2} oz. (Approx.)

Specifications subject to change without notice.

Accessories: Protective Case
Neck Strap (Black)
User's Manual

Option: Polaris Spot View 10
It changes Polaris Flash Meter into a 10° angle spot meter, useful to get an accurate reflected-light reading of particular area of subject, to get a reflected-light reading from a subject that's far away, to measure areas of different contrast on a subject.

Polaris Flat Diffuser
It is used to measure the lighting ratio between main and auxiliary light, to determine luminance values and to take exposure reading to flat subject such as paintings or copying documents.

Color Neck Strap (with Polaris logo)
Grey and Wine Red

POLARIS

Manufactured by
ASPEN CORPORATION
6-3-5, Shimbashi, Minato-ku, Tokyo 105-0004, Japan

PRINTED IN JAPAN